



**Witzel**

**Vacupress**

**WITZEL VACUPRESS e.K.**

Inh. Hendrik Witzel

Max-Keith-Str. 66 - D-45136 Essen

☎ +49 201 6462284 📠 +49 201 6462852

✉ info@vacupress.de 🌐 www.vacupress.de

# **Infrared-Oven** **IR1302 COMPACT**

*(Translation of Original-)*

- 1. Setup + assembling**
- 2. Manual instruction**

Before the first commissioning of the unit  
**read important safety instructions on page 15!**

**This manual is an integral part of the installation and must be handed over to a new owner in case of sale or to an operator in case of use by a third party.**

Version 2014/04 (B / SW1.4) / 208/50/1



INDEX	TABLE OF CONTENTS	PAGE
A)	<b>INTRODUCTION</b>	
A1)	General information	5
A2)	Manufacturer data	5
A3)	References	5
A4)	Type plate	6
B)	<b>SAFETY</b>	
B1)	General safety instructions	7
B2)	Residual risk	7
B3)	Pictograms	9
B4)	Personal protective equipment	9
<b><u>PART 1:</u></b>		
1.	<b>Setup + Assembling instructions</b>	<b>10</b>
1.1.	Introduction + part list	10
1.2.	Assembly	11
<b><u>PART 2:</u></b>		
2.	<b>Manual instructions</b>	<b>14</b>
	<b>Purpose of the IR1302</b>	<b>14</b>
2.1.	Attention	15
2.2.	Operation instructions	16
2.2.1.	The Infrared-Oven (case)	16
2.2.2.	The pull-out Tray	17
2.3.	Features of the controller (Touch panel)	22
2.3.1	Setup- and Information screens	23
2.3.2	Oven operation	31
2.3.3.	Error- and Alert-Messages	33
3.	<b>Application of the IR1302</b>	<b>34</b>
3.1.	General notes	34
3.2.	Heating of flat plastics directly on the Tray	34
3.3.	Heating of plastics with Blister-Forming frames	35
3.4.	Specials	37
3.5	Pre-Preg hose duct	37

<b>INDEX</b>	<b>TABLE OF CONTENTS</b>	<b>PAGE</b>
<b>4.</b>	<b>Care and maintenance</b>	<b>38</b>
<b>4.1.</b>	<b>Oven-housing</b>	<b>38</b>
<b>4.2.</b>	<b>Front-door</b>	<b>38</b>
<b>4.3.</b>	<b>Quartz-Infrared-Tubes</b>	<b>38</b>
<b>4.4.</b>	<b>IR-optical measuring-unit</b>	<b>39</b>
<b>4.5.</b>	<b>Illumination</b>	<b>40</b>
<b>4.6.</b>	<b>Pull-out Tray</b>	<b>40</b>
<b>4.7.</b>	<b>Teflon-coating</b>	<b>40</b>
<b>4.8.</b>	<b>Breaker / Fuse</b>	<b>42</b>
<b>4.9.</b>	<b>Error messages and Rectification of defects</b>	<b>43</b>
<b>5.</b>	<b>Circuit diagram</b>	<b>46</b>
<b>6.</b>	<b>Spare parts</b>	<b>47</b>
<b>7.</b>	<b>Technical Details</b>	<b>48</b>
<b>8.</b>	<b>Declaration of conformity</b>	<b>49</b>

## A) INTRODUCTION

### A1) GENERAL INFORMATION

These instructions are intended to provide the user and all authorised persons with important information about the safe use and maintenance of the IR1302 infrared oven. The instructions are a key part of the IR1302 infrared oven and must be properly stored for the entire lifetime of the equipment. In case of disposal, leasing or cession of the right to use the IR1302 infrared oven, the instructions must be transferred to the new user along with the EC declaration of conformity. Any intervention in the equipment is prohibited unless all instructions in this manual have first been read attentively and properly understood. The illustrations in this manual merely constitute examples and are not binding for the manufacturer. The manufacturer reserves the right to make changes to components and parts for the purpose of improvement or other reasons, without updating this manual, provided this does not alter the operation and safety of the IR1302 infrared oven.

### A2) MANUFACTURER DATA

*Witzel VACUPRESS e.K.*  
*Max-Keith-Str. 66*  
*45136 Essen*  
*Phone +49 201 6462-284*  
*Fax +49 201 6462-852*

Please have the following information ready before contacting the manufacturer about the IR1302 infrared oven:

- Model and serial number of the oven
- Year of manufacture
- Purchase date
- Detailed information about the problem

### A3) REFERENCES

For better understanding of the information provided in this manual, information and instructions about situations considered critical or dangerous are highlighted using the following symbols:



#### **DANGER**

Identifies instructions that can lead to hazardous situations for personnel if they are not observed.



#### **ATTENTION**

Identifies instructions that can cause damage to the oven if they are not observed.

#### A4) TYPE PLATE

Every IR1302 infrared oven has a type plate with the name of the manufacturer, the address, CE marking and the technical specifications.

The type plate is found on the rear of the control unit housing next to the power cable.

## B) SAFETY

### B1) GENERAL SAFETY INSTRUCTIONS

Reading these instructions before performing any work on the IR1302 infrared oven is important. Regardless of the information in these instructions, compliance with the safety regulations of the country where the oven is installed is mandatory. The requirements for the deployment of qualified personnel for various maintenance, operating and installation tasks must be observed.

The most important rules of conduct for the safe operation of the equipment are:

- Installation, operating and maintenance work always has to be carried out by qualified and trained personnel.
- Proper personal protective equipment always has to be worn, with no exceptions.
- All cleaning, adjustment and maintenance tasks may only be carried out after ensuring that the power supply has been disconnected.
- Never aim a jet of water at electrical components, even if they are protected by a housing.
- Never smoke during operation or maintenance, especially if solvents or flammable materials are used.
- Do not damage information signs or pictograms posted on the oven. If they should be damaged accidentally, install identical replacements immediately.

Witzel VACUPRESS assumes no liability for damage to property or personal injury resulting from the improper use of the oven, damage to its safety devices or failure to properly observe occupational safety regulations.

### B2) RESIDUAL RISK



#### **DANGER**

IR1302 infrared oven was developed so that the residual risk for the user and other personnel is reduced to a minimum. Exercise extreme caution and be very attentive when performing maintenance work. Familiarity after working with the oven frequently can often cause possible hazards to be forgotten or underestimated.

- **Danger due to high temperatures**  
The surface temperature on parts of the oven may exceed 70°C. Install the oven in a protected area which is only accessible to authorised personnel. Prior to any intervention, allow the oven to cool and/or wear corresponding personal protective equipment (heat protection gloves).
- **Danger due to underpressure**  
Avoid contact with the intake ports when operating the oven with the vacuum source connected. Ventilate the intake circuit prior to any intervention in the system. Contacting areas with underpressure may represent a source of accidents.
- **Risk of electric shock**  
There are live components in the electrical system of the IR1302 infrared oven, which can result in severe personal injury and damage to property in case of contact. Any intervention in the electrical system must be carried out exclusively by qualified personnel.
- **Fire hazard**

Using the IR1302 infrared oven for purposes that are not intended or are prohibited by these instructions, and lack of or improper maintenance, may result in malfunctions associated with a risk of overheating and fire. Do not use water as an extinguishing agent in case of fire. Only use powder or CO2 fire extinguishers or other extinguishing agents suitable for electrical systems.



### B3) PICTOGRAMS

Pictograms with warnings and safety symbols for the user are installed on the IR1302 infrared oven. The symbols and their meaning must be read carefully and observed prior to using the oven.



**RISK OF ELECTRIC SHOCK**  
Proximity to (protected) electrical connections; accidental contact may result in electric shock or death.



**DANGER HOT SURFACES**  
Proximity to surfaces with a temperature in excess of 70°C, which may lead to moderately severe burns.



**DANGER HOT MATERIALS**  
Proximity to hot materials or surfaces with a temperature of more than 70°C. Always wear heat protection gloves to prevent burns.

Witzel VACUPRESS accepts no liability for personal injury or damage to property due to failure to observe rules and regulations indicated by the pictograms, or if the pictograms are not in proper condition.

### B4) PERSONAL PROTECTIVE EQUIPMENT

These operating instructions are based on the assumption that the IR1302 infrared oven is installed in a place of work where all mandatory safety regulations are observed; in particular, the personnel must wear suitable personal protective equipment during all activities.



## 1.2. Assembly

The IR1302 COMPACT is designed as a bench top unit. It can be installed either on a suitable desk / work-bench or a shelf-like stand. ATTENTION! The desk / stand needs to be suitable for the load of the oven of 230 kgs. The minimum payload of the desk / stand needs to be 250 kgs!



ATTENTION! SAFETY HAZARD!  
IN CASE OF USING IMPROPER STANDS OF  
UNDERRATED PAYLOAD

The assembly has to be done on a flat ground.

- 1.2.1. First remove the top and the four sides of the box. The oven is shipped on its backside (pic. 1a). Thus it can be moved through every door of at least 75cm width.



pic. 1a

- 1.2.2. First prepare the work-bench / stand the oven shall be set on. Ensure a proper stability! With help of three to four people now tilt the oven to the front and set it on the floor on its rubber feet. After that you can lift the oven with five to six people and set it on top of the work-bench / stand. **ATTENTION! Never lift the oven at the black switch box!**
- 1.2.3. Finally ensure that the oven is sitting properly on the work-bench / stand and is secured against shifting. Note: The rubber feet can be disassembled and the four square tubes of the oven can be slide into suitable outer tubes.

1.2.4 . Finally you can remove the two transport locking devices on top of the oven case. For this push down the Front door until it locks at the end position. Now the upper edge of the door should not contact the transport locking devices any longer. Now loosen the screws on top of the locking devices (pic. 6). Remove the transport locking devices and mount the screws at the oven lid again. Keep the transport locking devices for future

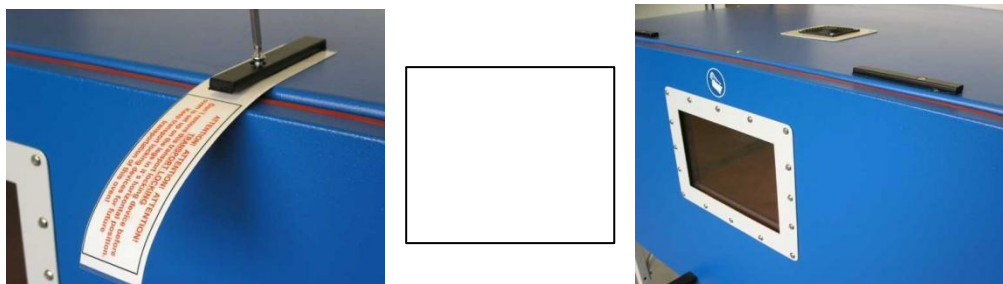



## **Part 2.**

# **Manual instructions - Infrared-Oven IR1302 COMPACT**

### **Purpose of the IR1302 COMPACT**

The use of the IR1302 COMPACT Infrared-Oven is restricted to the following purposes:

1. Heating of thermoplastic materials directly on the Pull out Tray
2. Heating of thermoplastic materials which are clamped into an extra Blister-Forming frame which can be put on a cradle (option, e.g. Article 07-131).

**All other applications are not allowed!**

IT IS NOT ALLOWED TO USE MATERIALS WHICH CONTAIN SOLVENTS OR OTHER  
INFLAMMABLE SUBSTANCES!



ATTENTION! DANGER OF SPONTANEOUS IGNITION OR DETONATION OF SOLVENT  
CONTAINING GAS!

## 2.1. ATTENTION



### ATTENTION

Verify that the mains voltage and frequency match the values specified on the type plate.

2.1.1 The electrical connection provided should be checked by an expert to verify that the wiring conforms to the standards.

***Incorrect assignment of the n-terminal device can result in the immediate destruction of components!***

2.1.2 Correct wiring is not assured, even if other machines have operated properly using the connection provided.



### DANGER

Work on electrical equipment and components may only be completed by trained, qualified personnel or licensed electricians!

In case anything is unclear, our technical customer service can be contacted.

Witzel VACUPRESS e.K.  
Max Keith Str. 66  
D-45136 Essen - Germany  
Phone +49/201/6462-284  
Fax +49/201/6462-852  
E-mail: [info@vacupress.de](mailto:info@vacupress.de)

## 2.2. Operation instructions

Before you start to work please have a look on the components and actuators of your IR1302 COMPACT as shown and described below.

### 2.2.1 The Infrared-Oven (case) (pic. 9)

The case of the oven includes beside the electronic devices the quartz-infrared tubes (heating) and the optical temperature measuring unit.

### 2.2.1 The Infrared-Oven (housing) (pic. 9)

The case of the oven includes beside the electronic devices the quartz-infrared tubes (heating) and the optical temperature measuring unit.

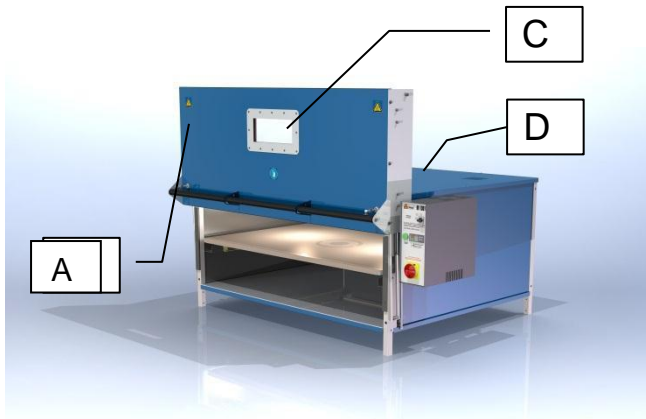

pic. 9

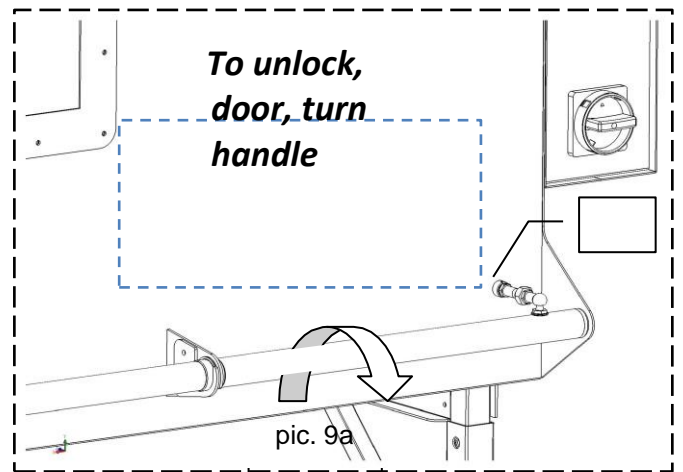

#### 2.2.1.1 FRONT-DOOR – pic. 9

The door (A) of the IR1302 COMPACT is designed as a vertical sliding door, which helps to save a lot of space while opening and closing the door. It is guided by two side-mounted ball-bearing telescope bars and lifted by two gas springs. The door is locked at the lower end position by two adjustable notches (B). To unlock the door, turn handle.

NOTE: As soon as the oven door is opened, the IR-tubes are deactivated to save energy.

#### 2.2.1.2 DOUBLE PANE VIEWING WINDOW – pic. 9

The double pane viewing window (C) is integrated into the Front door and allows to control the heating process while the door is closed.

#### 2.2.1.3 FAN FOR THE OPTICAL SENSOR

A fan which cools the optical sensor is integrated on top of the oven. The fan is running all the time while oven is switched on by the ON-OFF main switch.

**ATTENTION! NEVER COVER THE FAN BECAUSE ITS FUNCTION IS AFFECTED AND THE OPTICAL IR-SENSOR CAN BE OVERHEATED BY THIS.**



#### 2.2.1.4 INFRARED-QUARTZ-TUBES (HEATING ELEMENTS) – pic. 10 (A)

The oven is equipped with 18 Infrared heating elements. The Quartz-tubes are equipped with single reflectors and can be replaced one by one if required. The Heating (area) can be switched in two zones by use of the Heating selection feature of the controller. Zone 1 turns on the 6 central tubes only to heat small pieces of material or a Blister-Forming frame. Zone 2 turns on all 18 tubes to heat larger pieces of material up to the whole size of the tray. The heating elements of the outer rows are lifted a little bit at the outer end. This is not a malfunction, but allows a better heating of the edges.



Abb. 10

#### 2.2.1.5 OPTICAL TEMPERATURE-SENSOR – pic. 10 (B)

The IR 1302 COMPACT is equipped with an optical Temperature-Sensor (IR-sensor). The sensor is placed on top in the middle of the heating area between the tubes. The IR-sensor looks on the material from the top and measures the surface temperature of the material placed in the measuring area.

#### 2.2.1.6 ILLUMINATION – pic. 10 (C)

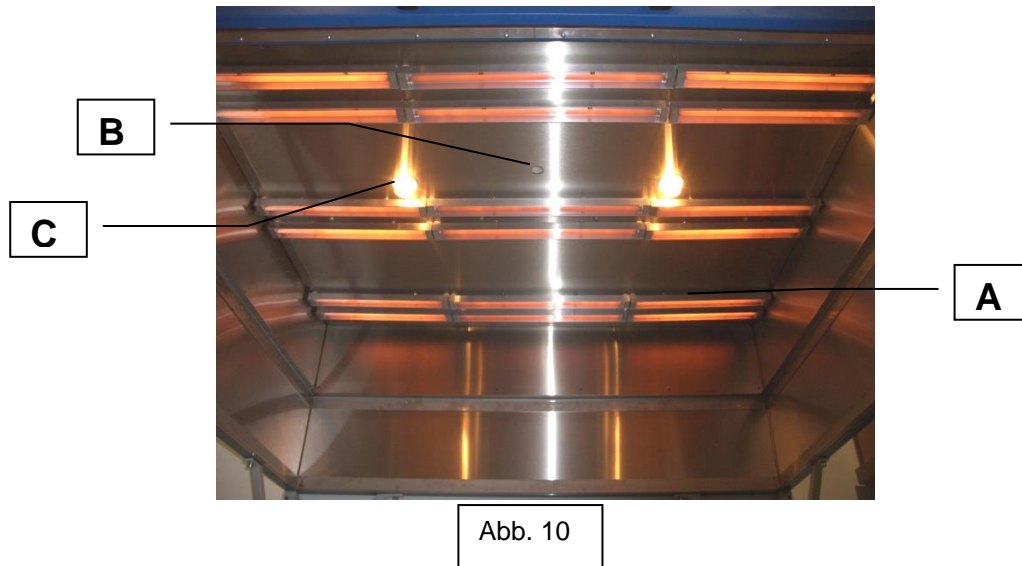
The IR 1302 COMPACT has two 25W bulbs for illumination. The bulbs are automatically activated when the oven is turned ON and OFF by the main switch.

### 2.2.1.7 ON-OFF SWITCH – pic. 11 (A)

The oven is turned ON and OFF by use of the main switch (A). As soon as the oven is turned ON the controller (Touch-panel), the illumination and the fan of the optical sensor are running.

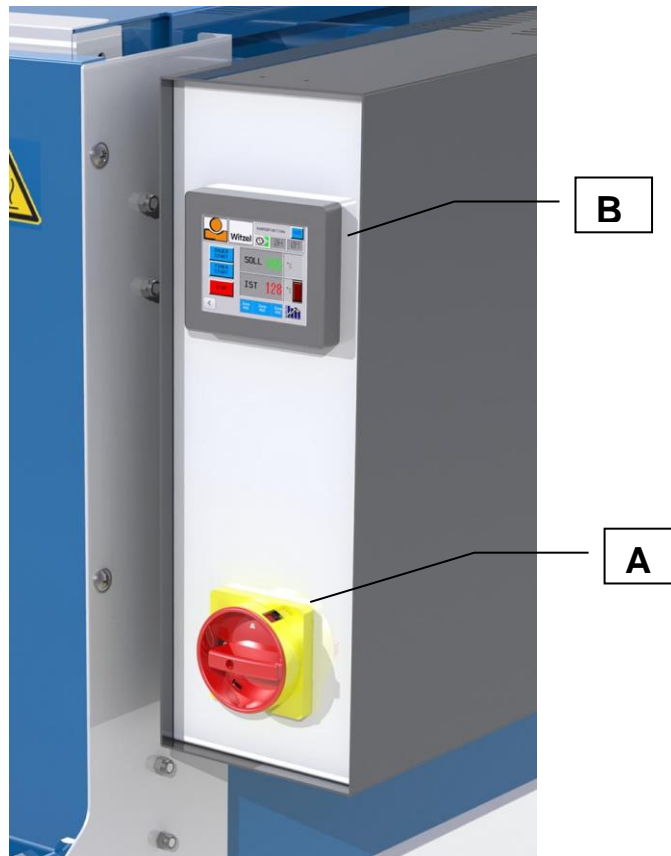

pic. 11

### 2.2.1.8 CONTROLLER (Touch-panel) – pic. 11 (B)

The controller is the central unit of the oven. It is equipped with a microprocessor controller and a touch sensitive panel for user in- and output.

### 2.2.1.9 EXTERNAL USB PORT – pic. 11 (not visible)

The software of the controller can be updated by an USB port at the backside of the switch box. The update is applied by a USB stick. The update shall only be applied under instruction of our service personnel. In any way no other USB devices may be connected to this port. ATTENTION! Misuse can cause irreversible damage of the installed soft- and/or hardware.

#### **2.2.1.10 Safety-Thermostat**

In case of a malfunction of the Temperature control elements, the IR1302 COMPACT is equipped with a safety-thermostat (STB) which turns off the oven when overheated. In that case the oven is shut down completely. The STB is located at the backside of the black switch-box. After the STB has tripped, turn off the main-switch (A) and let the oven cool down. After the oven has cooled down, you can reset the STB by pushing the red button until you hear it locking. Should the STB trip again, please contact our technical service.

## 2.2.2. The Pull-out-tray – Pic. 13 (A)

The Pull-out-tray is designed to slide out on ball-bearing guides completely. The tray is covered with a robust nonstick Teflon-coating which is replaceable. Below the Teflon-coating in the middle of the tray is a marking for the optical sensor. Thus you can easily place and remove the material from the tray. The pull-out-tray is designed for flat plastics. To heat prosthetic socket materials with Blister-forming trays the Pull-out-tray needs to be disassembled.

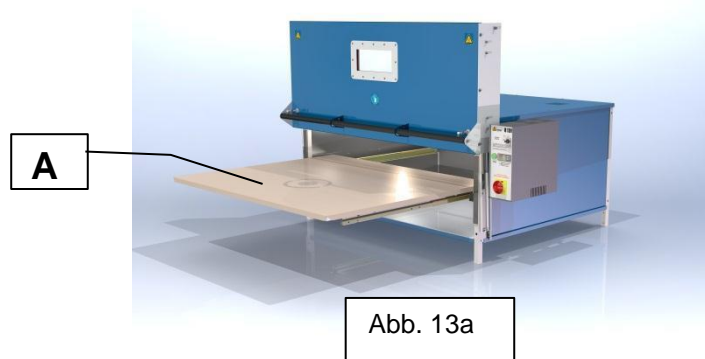

### 2.2.2.1 Disassembly of the Pull-out-tray

To process Prosthetic socket materials with Blister forming trays, the Pull-out-tray needs to be disassembled. The tray is mounted to the ball-bearing guides by use of a quick-release locking.

Open the oven door and pull out tray completely (pic. 13a). Remove the two knurled-screws (C) (pic.13b) at the left and right bracket of the tray. Now you can pull the tray to the front for another 2 cm. By help of a second person (due to the dimension of the tray) the tray can now be lifted from the bolts of the ball-bearing guides.

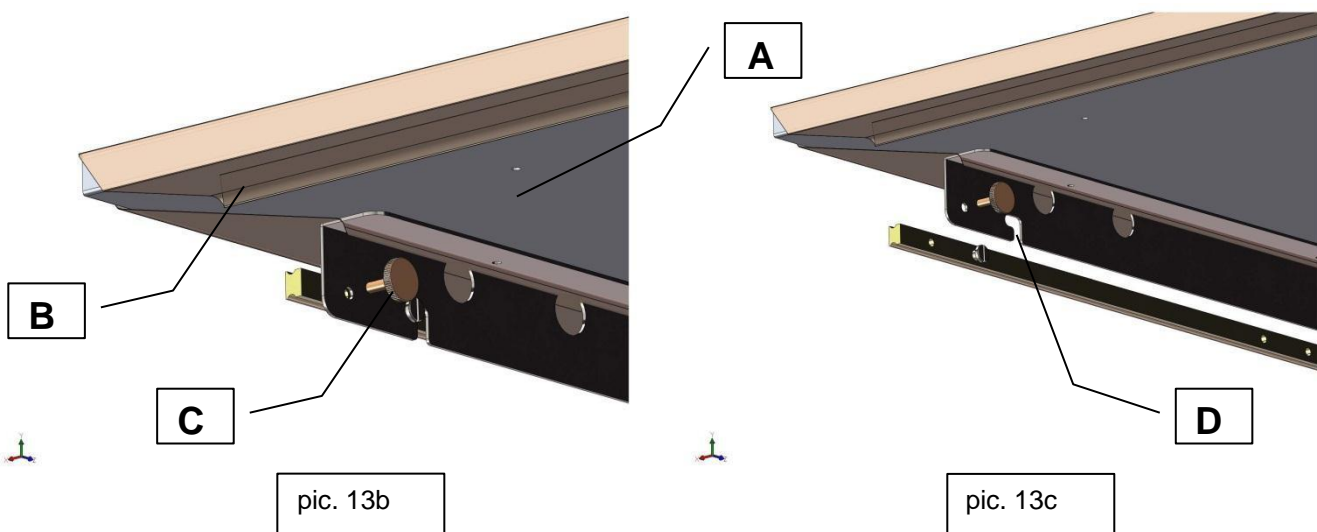

Now put the tray carefully aside and take that the Teflon coating will not be damaged. (Tip: You can put the tray on top of the oven. But take care that the cooling-fan on top will not be covered). Finally slide in the ball-bearing guides. Now the oven is prepared for using Blister- forming trays.

To assemble the tray back to the oven, just go ahead in reverse order.

### 2.2.2.2 The Teflon coating – pic. 13

The Teflon coating prevents materials from sticking to the tray. The Teflon coating consists of a robust chopped-strand mat and can be replaced when necessary. To guarantee a lifetime as long as possible it is recommended that it is not scratched or damaged by sharp items.

### 2.2.2.3 Marking for the optical sensor – pic. 14

The IR1302 COMPACT has an optical temperature sensor. This sensor „looks“ on a central area of the tray. When you put smaller pieces of material into the oven you have to be sure that they are placed right in this measuring area. To make this easier there is a marking in the middle of the tray which shows the measuring area (Roll about tray completely slid into the oven). As the tray is height adjustable the measuring areas varies. The inner circle (A) shows the measuring area with the tray in the upper position. The outer circle (B) shows the measuring area with the tray in the lower position.

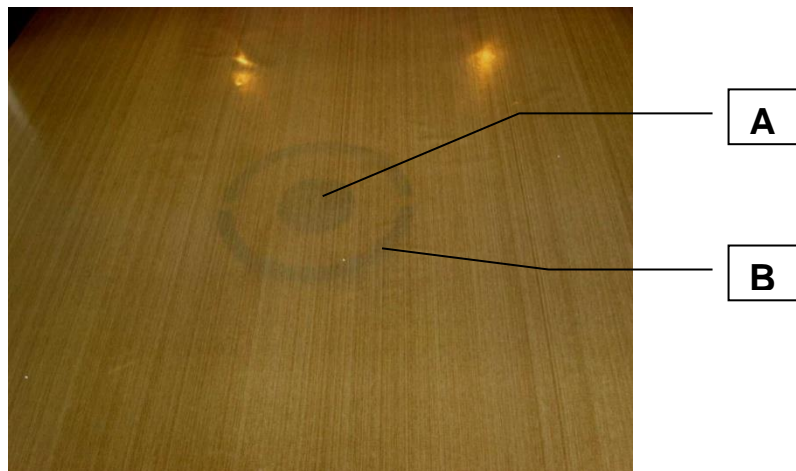

pic. 14

## 2.3. Feature of the controller (Touch-panel)

The IR1302 COMPACT is equipped with a programmable control (SPS) which is capable to integrate multiple features. The user in- and output is realized by a touch sensitive 3,5" TFT screen which can be handled intuitively by finger or stylus input. The different screens are explained below.

### 2.3.1. Setup- and information-screens

#### 2.3.1.1. Start

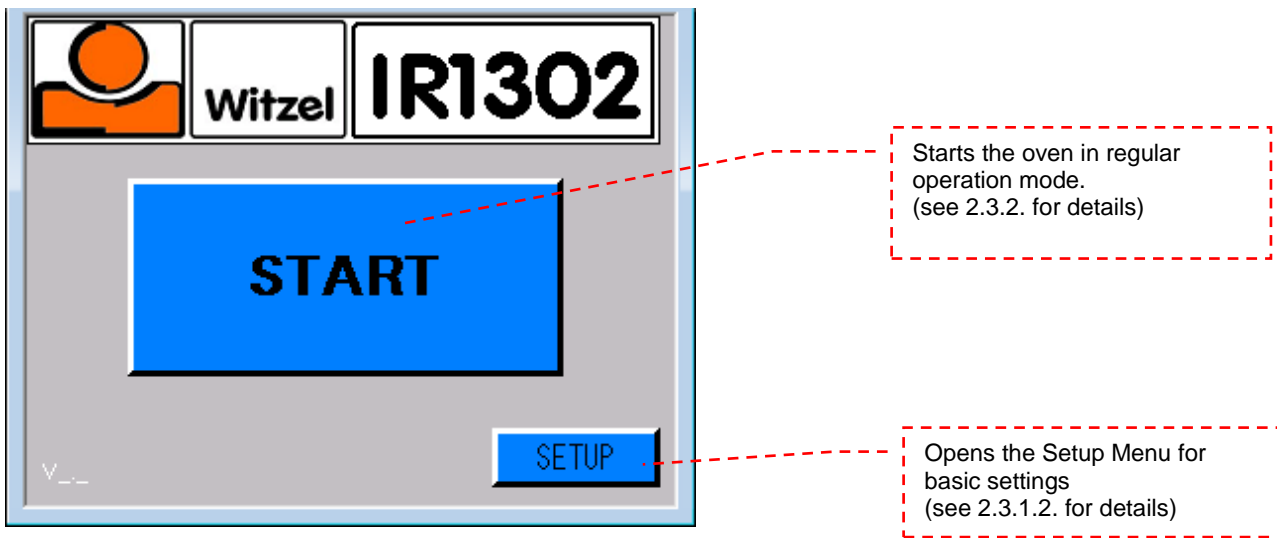

After turning on the oven the controller runs a self-test. After a few seconds the above start screen is displayed.

To start running the oven in operation mode push „START“ (for further details refer 2.3.2). By use of the „Setup“ button the submenu for basic settings is entered(see 2.3.1.2. for details).

## 2.3.1.2. Setup

The Setup screen consists the buttons for switching the different menu languages as well as the buttons for further configuration options.

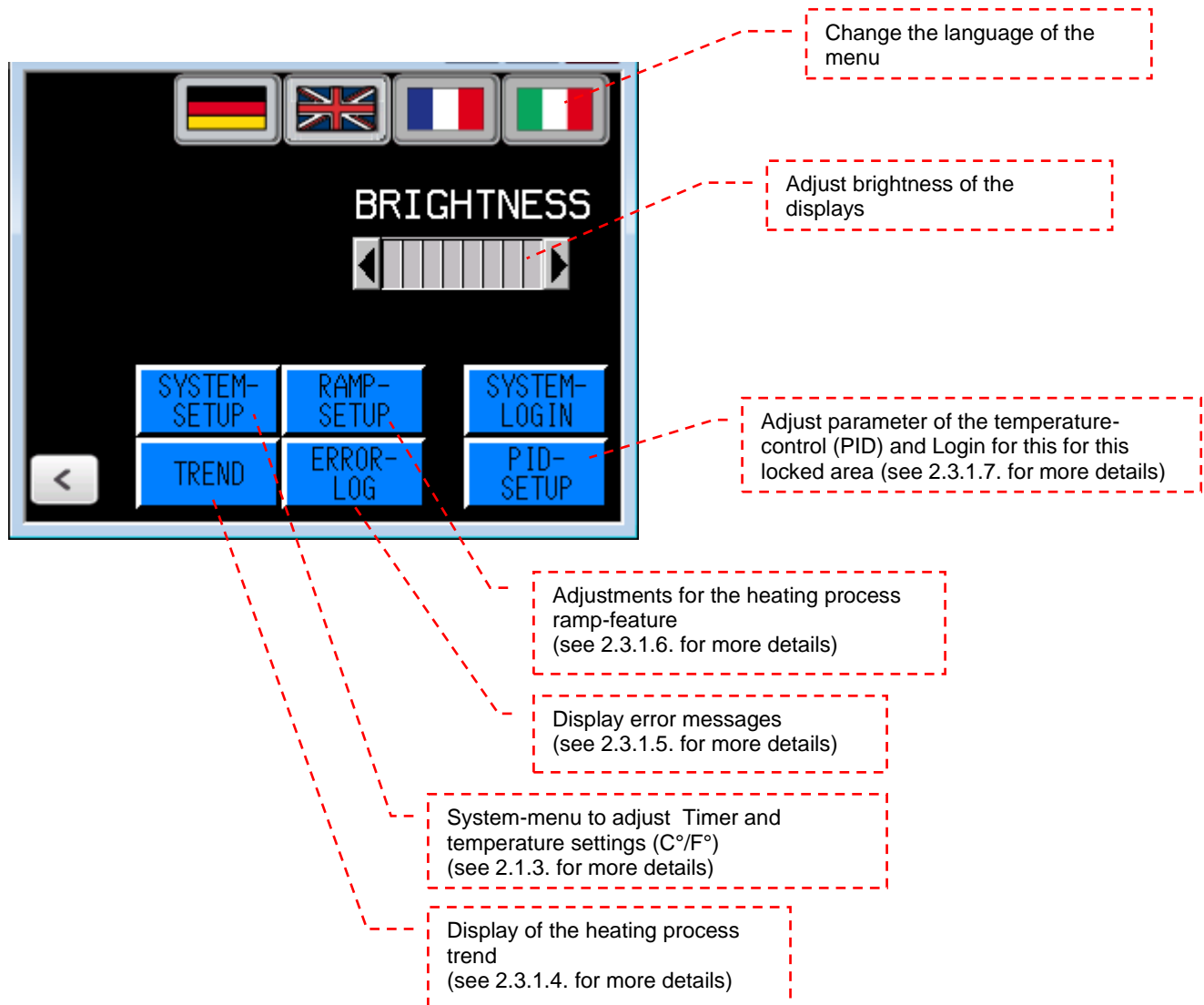

### 2.3.1.3. System-Setup

The system setup screen consists the timer setup to preset the time in hours and minutes further the temperature setting can be selected between °C and °F. ATTENTION! Switching the temperature setting will NOT convert the numbers in all operation modes as well as the heating ramp setup. These numbers must be adjusted manually after the temperature setting has been switched between °C and °F!

At the bottom of the screen the current system time is displayed. The feature "TIME SETUP" opens a screen where the system time and date can be adjusted.

At the upper right corner the serial number of the oven is displayed. The serial number is required at maintenance requests or spare part orders.

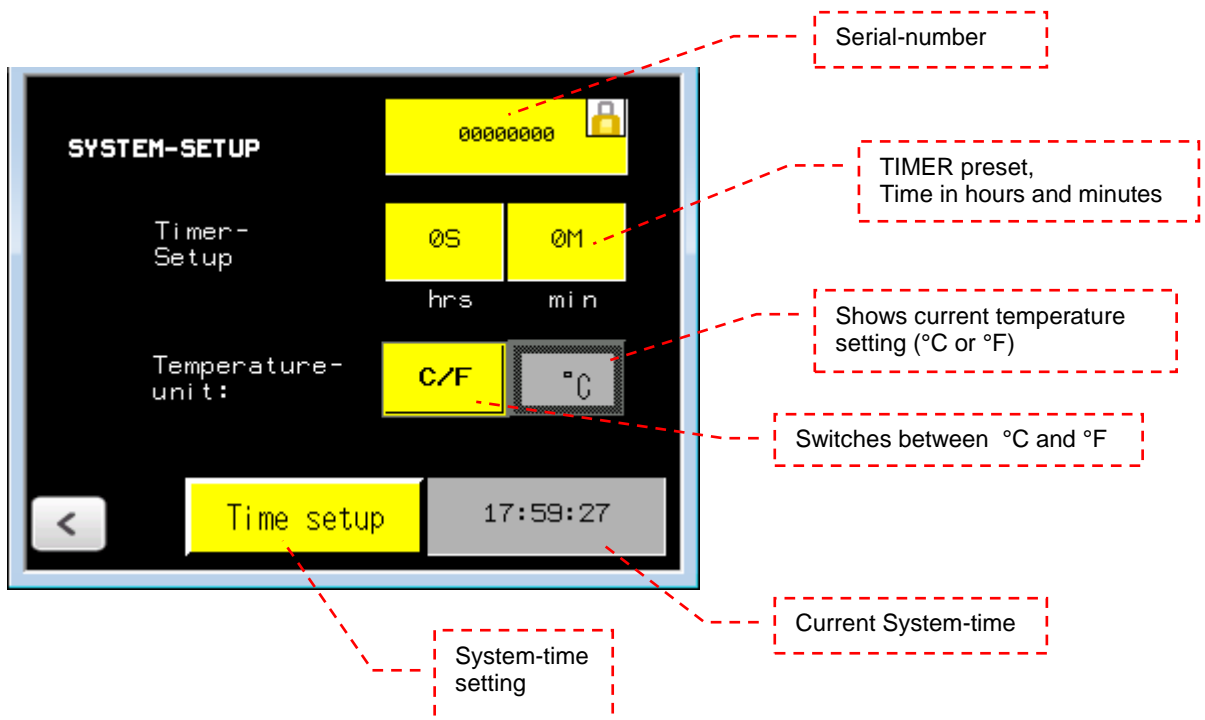



### 2.3.1.4. Heating process trend

The TREND screen gives an overview of the current heating process. Shown at the display is a graph of the MATERIAL-TEMPERATURE. The timeline can be scrolled by use of the BACK and FORWARD buttons. The END button jumps to the current time.

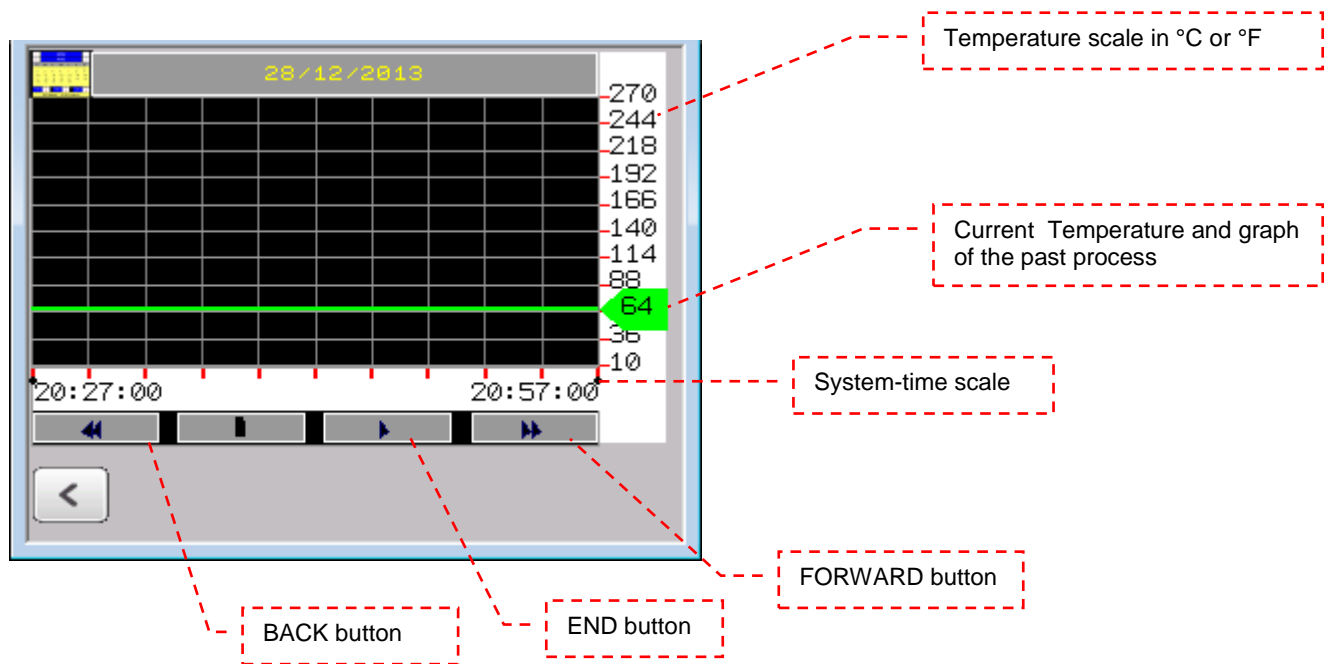

### 2.3.1.5. Errors

The error log stores disturbances and errors since the last turn on. An error could be a temperature sensor which does not work properly.



Zeit	Meldung	Ber
16:07:25	Modell Fühler nich	
16:07:51	Modell Fühler nich	

Error messages in chronological order

### 2.3.1.6. Ramp-setup

The ramp setup menu provides programming and activation options to allow a slowly heating with a raising heating ramp. The IR1302 COMPACT offers the capability of saving different Temperature-profiles.

The ramp setup screen shows a conventionalized heating graph which is partitioned in to five segments. The user can individually adjust the temperature and time for each segment. Further an alarm can be set which is activated as soon as the end of the particular segment is reached (visual alarm at the screen and by blinking yellow tower light plus audible alarm). The user can confirm an activated alarm at the screen. During an active alarm the heating process runs regularly.

The screenshot shows the Ramp-setup interface with the following callouts:

- Add Temperature-Profile**: Points to the 'NEW' button.
- Delete existing Temp.-Profile**: Points to the button with a flask and an 'X'.
- Select Temperature-Profile**: Points to the dropdown menu.
- Load Temperature-Profile**: Points to the button with a flask and a document icon.
- Write input values to Temperature-Profile**: Points to the button with a flask and a document icon with a pencil.
- Save Temperature-Profile**: Points to the button with a flask and a floppy disk icon.
- Switch to set Ramp-feature ON/OFF**: Points to the 'Ramp OFF' button.
- Tag of the segments 1-5. As soon as a segment tag is activated (yellow tag), the particular input mask is shown at the upper left corner.**: Points to the yellow tag on the graph.
- Online Help**: Points to the '?' button.
- Input mask for segments 1-5**:
  - Temperature
  - Time
  - Alarm ON/OFF
- When „RAMP ON“ is activated the total time of the heating process is displayed.**
- As soon as the heating process is started, the remaining cycle time of the heating process is displayed**

An online help is available for further explanation of the buttons. Pressing the (?) button will open a screen where detailed information for each button of the ramp-feature can be found.

The online help screen displays the following information:

- Load Temperature-Profile**: (Icon: flask and document)
- Write new values to Temperature-Profile**: (Icon: flask and document with pencil)
- Save Temperature-Profile**: (Icon: flask and floppy disk)
- Delete Temperature-Profile**: (Icon: flask and 'X')
- Sets Alarm which will be activated as soon as Segment is reached**: (Icon: bell)
- Rampe AUS**: Turn ON/OFF Ramp Feature

To use a heating ramp a temperature-profile must be selected from the list and loaded into the controller by use of button (A).

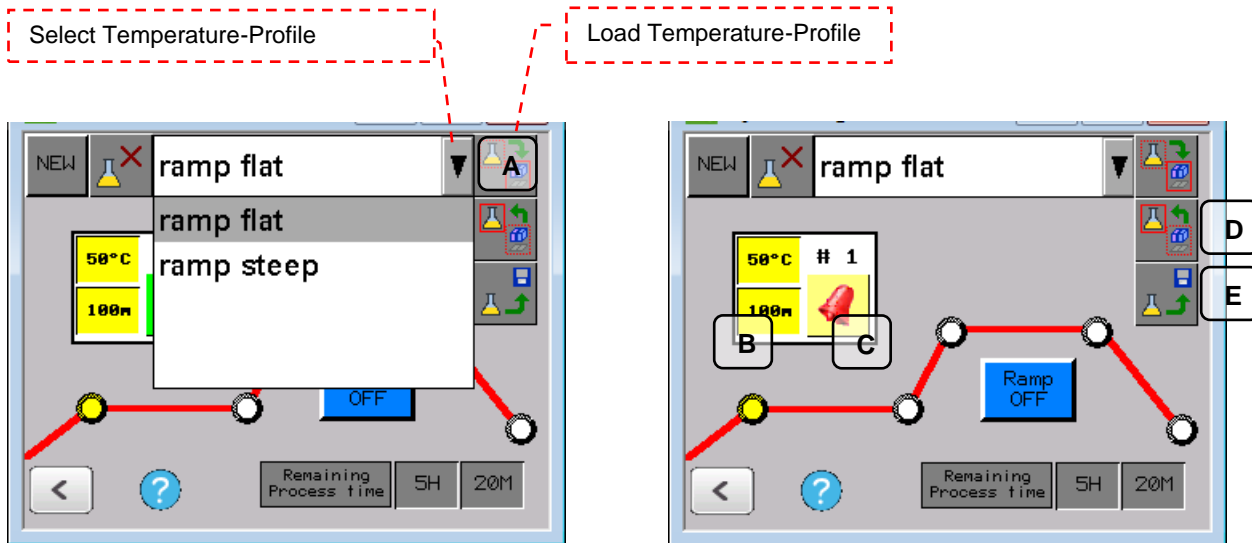

The stored values of segment 1 (yellow tap at red heating graph) will now be shown at the input mask (B). To show values of segment 2-5 the particular tap has to be activated. The values of the input mask will change to the activated segment.

Beside the temperature which shall be reached at the END of the segment the input mask allows to enter the time value the segment shall last. Further an Alarm can be set by use of button (C). An activated alarm (button is highlighted in green) will cause a visual alarm at the screen when the end of the segment is reached. The user can reset the alarm at the screen. (IMPORTANT NOTE: During an active Alarm the heating process will NOT be stop but normally proceed. The alarm is designed to remind the user of a potential intervention at this point of the heating process.

IMPORTANT NOTE! As soon as values have been changed at the input mask these need to be written back and stored at the Temperature-Profile first! To write back the values, button (D) has to be pressed and then stored by use of button (E). Otherwise the changed values will be lost and will not take effect at the current heating process!

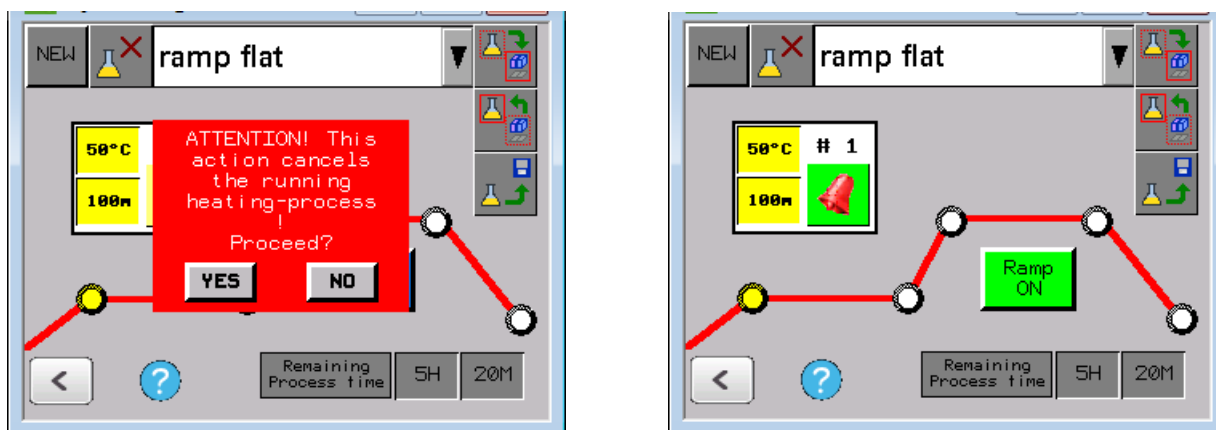

Finally button (F) need to be pressed to activate the Ramp-feature. After passing a reminder note the ramp-feature is activated and button (F) will change color from blue to green.

The ramp-feature status is also displayed at the main screen at the upper right corner.

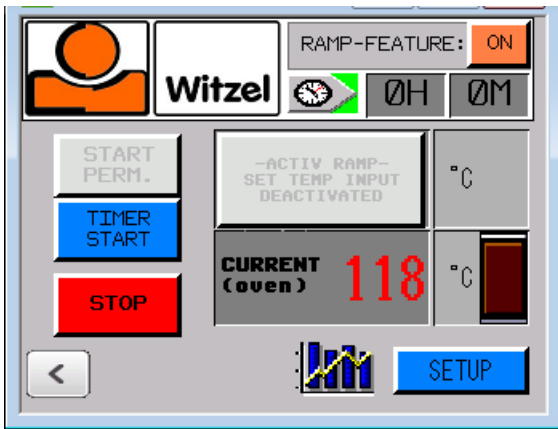

As soon as the ramp feature is activated the button for permanent oven operation as well as the set temperature input are deactivated. Both parameter are controlled by the ramp-feature resp. the Temperature-Profile of the heating-process.

With activated ramp-feature also the timer value will be overwritten. The active ramp-feature always calculates the total time by adding segments 1-5 of the activated Temperature-Profile.

### 2.3.1.6.1. Adding additional ramps:

Additional ramps can be set up by the user as follows:

- 1) Select „NEW“ button
- 2) Selecting the new entry at the Temperature-Profile list will open the text keypad and the user can enter an individual name for the new Temperature-Profile. Pressing „ENTER“ will close the keypad again.
- 3) Next the nominal values of segment 1 to 5 are entered for the Temperature –Profile.
- 4) **IMPORTANT! When finished, the new Temperature Profile written back by pushing button (D) and then saved by button (E). Otherwise the data that were entered are lost in the next step.**
- 5) Now another ramp can be created in the same way, or the ramp that has just been set up can be started (see above).

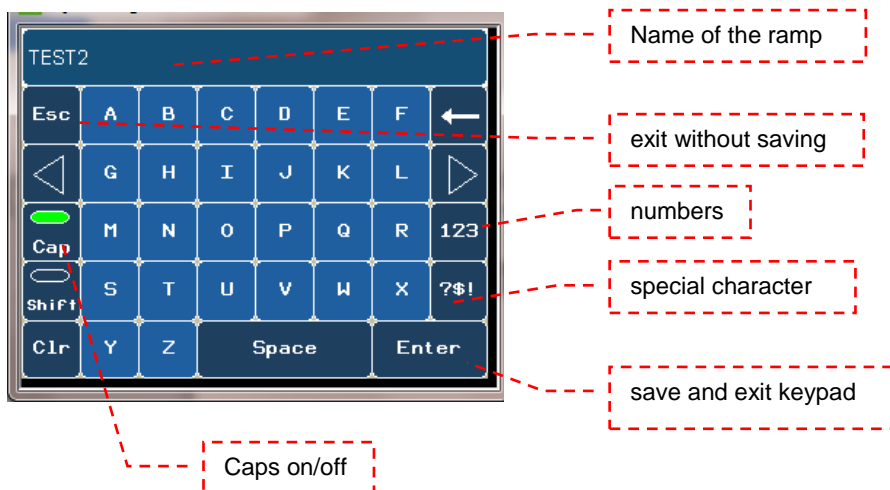

### 2.3.1.6.2. Renaming a ramp:

The names of the ramps that have been set up can be changed individually by the user as follows:

- 1) Select the Temperature-Profile to be changed from the list.
- 2) Tapping the name displayed opens the text keypad where the user can change the name of the Temperature-Profile. Select "ENTER" to close the text input screen when finished.
- 3) **IMPORTANT! When finished, the new Temperature-Profile to be saved by use of button (E). Otherwise the data that were entered are lost in the next step.**

### 2.3.1.7. PID-Setup- und System-Login

The temperature setting parameters are administered in the PID setup menu. To ensure proper functioning of the oven, these parameters must not be modified without instruction. Therefore they are protected against unintentional changes by a system login.

The login data are provided by technical customer service when they are required.

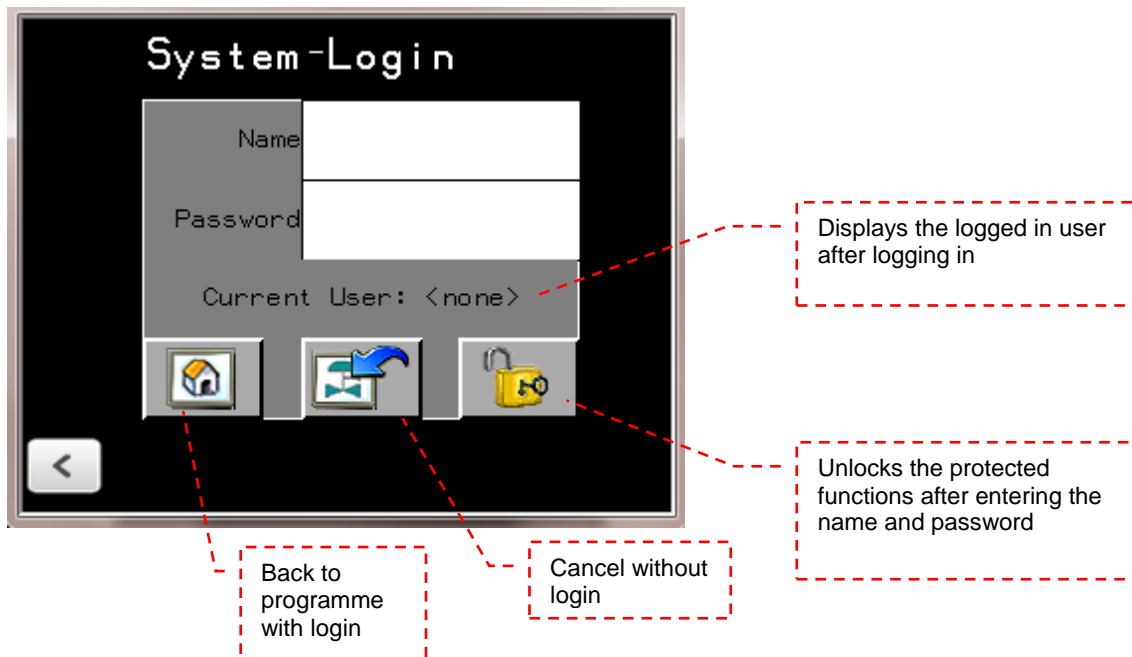

When the system is shut down the user that is currently logged in is automatically logged out again.

## 2.3.2. Managing the oven

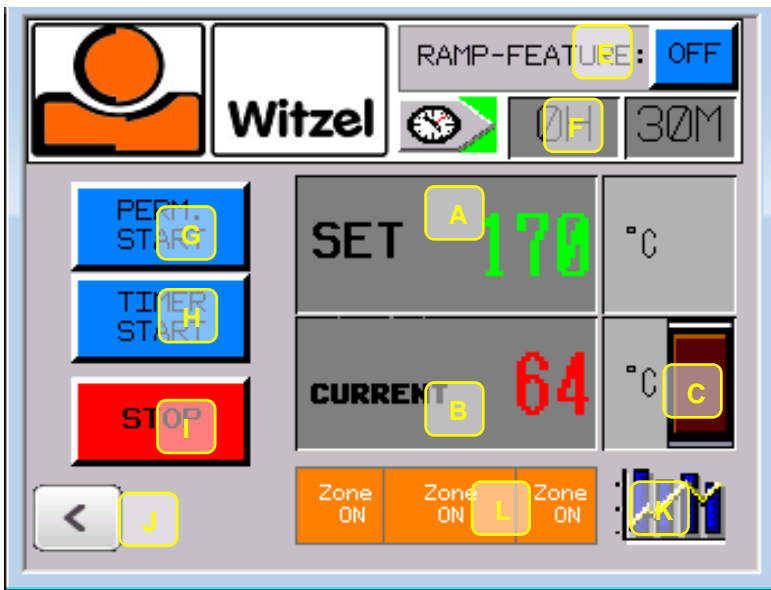

- A - SET** Setting the nominal temperature. Tap the green number to set.  
NOTE: With an active heating ramp the SET temperature input is locked as the temperature control is handled by the heating ramp during this operation mode.
- C - CURRENT** Display of the oven temperature (an optical sensor measures the surface temperature of the material (marking at the table) active in operating mode "Control via oven temperature")
- D - LED red** Lights up/flashes when oven heating is active
- E - Ramp Function** This button opens the "Ramp Setup" menu screen. For more information about setup and activation, see 2.3.1.6. In addition, the blue LED indicates the current status "ON" or "OFF" for the ramp function.
- F - TIMER** This button opens the system menu screen. Here the time for the timer function can be preset in hours and minutes. For more information, see 2.3.1.3. The preset time is displayed next to the timer button. When timer operation has been started with the "H" button, the remaining time is displayed.
- G - START PERMANENT** This button starts the oven in continuous operating mode. During active operation, the color of the button changes from blue to light green. Note: When the ramp function is active, this button has no function since the ramp function can only be used in timer operating mode. When exiting the operating mode using the "J" button during active operation, the warning "ATTENTION! This action cancels the current heating process! Continue?" is displayed. The option "YES" stops the heating process and returns to the start screen. If "NO" is selected, the heating process keeps running.
- H - START TIMER** This button starts the oven in timer operating mode. During active operation, the color of the button changes from blue to light green. When exiting the operating mode using the "J" button during active operation, the warning "ATTENTION! This action cancels the current heating process! Continue?" is displayed. The option "YES" stops the heating process and returns to the start screen. If "NO" is selected, the heating process keeps running.
- I - STOP** This button stops operation of the oven in any operating mode.
- J - "<"** This button closes the current screen, returning to the previous screen (applicable to all screens).
- K - PROCESS** This button opens the process screen. An overview of the current heating process is displayed in the process screen. For more information, see 2.3.1.4.
- L - HEATING SELCETION** The IR1302 COMPACT is equipped with a 2 zone heating selection feature which allows to adjust the active heating area to the material size. For small pieces of material a just the center row of Infrared-tubes can be activated. For larger sheets and blister forming sockets the entire heating area of all three rows

of infrared-tubes can be activated. The button shows the current status of the zones (blue deactivated, orange activated). Pushing the button opens a screen where the active zones can be selected. See 2.3.2.1. for more details. Note: Opening the door of the oven will automatically deactivate all zones which is also displayed at the screen.

### 2.3.2.1. Heating selection feature

The heating selection feature allows to adjust the active heating area to the material size. The heating zones (center zone and outer zone) are activated (orange) and deactivated (blue) by touching the respective areas. The center zone cannot be deactivated as this area is monitored by the optical temperature sensor. Setting the oven on stand-by mode is done by use of the STOP-button „I“. The two outer zones are always turned on and off together.

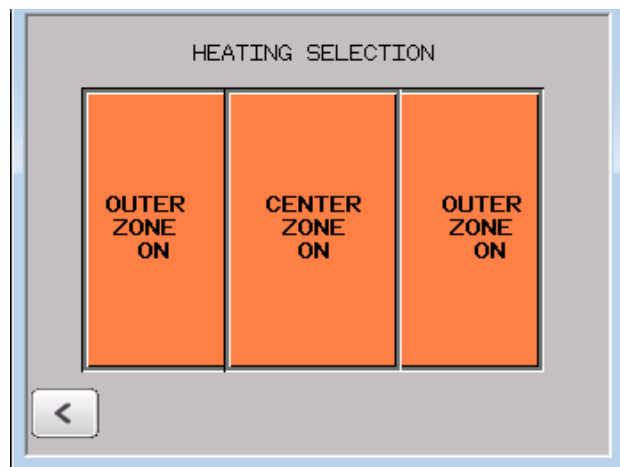
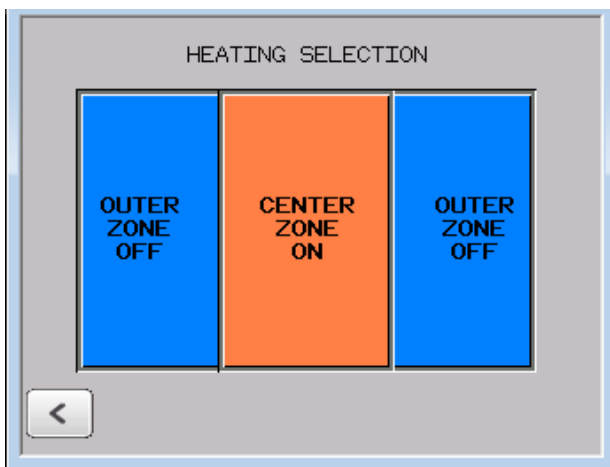



### 2.3.3. Error- and Alert-Messages

Possible Error- and Alert-Messages of the system are listed below.

#### 2.3.3.1. Open door

This message shows up as soon as the door is opened during a running heating process. As it can happen that the door is opened intentionally during a running heating process, this process is NOT stopped by the open door. Nevertheless the Infrared heating is deactivated automatically as long as the door is opened. After the door has been closed again, the heating process is continued regularly.

#### 2.3.3.2. Termination of the heating process

As soon as the "<" button is tapped, the ramp feature is tried to turn ON or OFF or the temperature setting (°C/°F) is tried to switch, a message is shown up that the intended feature will terminate the current heating process. The message can be confirmed by tapping "YES" or the user can return to the current heating process without changes leaving the message with "NO".

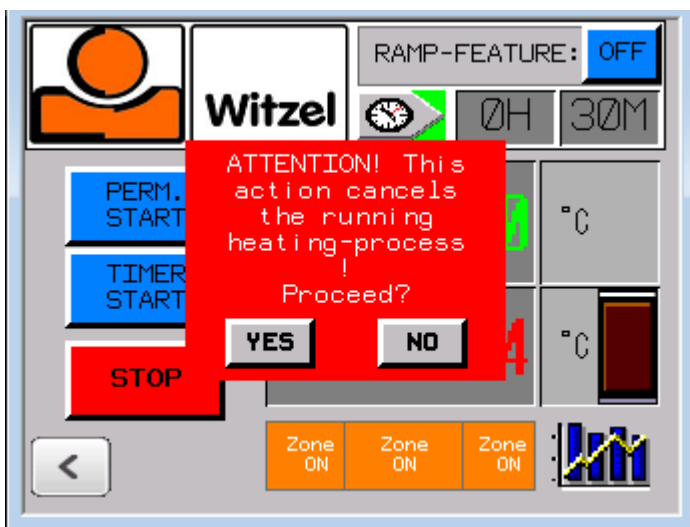

### 3. Application of the IR1302 COMPACT

#### 3.1 General notes

The infrared oven IR1302 COMPACT can be used to heat all thermoplastic materials which are in the market. Concerning the process instructions, especially the process temperature please follow the recommendations of the manufacturer. Best results will be achieved when the recommended temperature is set. In case of unexpected problems or any questions please don't hesitate to contact our technical service.

Due to the system and the used components **no pre-heating** of the IR1302 COMPACT is necessary (different to convection ovens). The system works with infrared radiant heat and has 100% effect already a few moments after it is turned on. Further the IR1302 COMPACT can be directly turned off when not in use. This can of course also be done by the STOP button of the main screen which deactivates the heating elements and sets the oven to a kind of stand-by mode. Thus only the illumination, the controller and the cooling fan are dissipating only little energy. If this followed and the heating of the IR1302 COMPACT - as intended at its development – is only turned on when needed, a lot of energy will be saved and the components of the oven will be protected!

#### 3.2. Heating of flat plastics directly on the tray

- The IR1302 COMPACT is turned on by use of the ON-OFF main switch (pic. 11 (A)). After the Start screen shows up the operation mode is selected by pushing the START button
- by pushing the green SET temperature it can be adjusted to material to be heated. The number will be set by pushing the ENTER button at the keypad.

ATTENTION! To get the best heating results the temperature recommended by the manufacturer should be selected! Selecting a higher temperature does **NOT** heat the material faster but overheats and burns the material and destroys the material most times!



ATTENTION! DANGER OF SELF-IGNITION  
OF OVERHEATED MATERIAL!

- The door of the oven is opened by turning the door handle and pulling it upright.
- The Pull out tray can be slide out of the oven at the front end

-By use of the HEATING SELECTION feature the size of the heated area can be selected. Selecting the correct size helps to save energy.

CENTER ZONE = activates 6 central infrared tubes  
(for small pieces of material)

OUTER ZONE = activates 12 outer infrared tubes  
(for larger pieces of material + Blister forming)

- Now the material is put at the tray. **When using smaller pieces of material it is necessary to put those right into the middle of the marked measuring area at the tray!** Only thus a correct determination of the materials surface temperature is ensured!
- The Pull out tray is pushed completely into the oven again and the front-door is closed by pushing it down until it locks at its end position.
- The heating process will be started by activating the PERM START button - or if desired by activating the TIMER START button.
- Now the heating process can be observed at the front-door's viewing window or the CURRENT temperature displayed at the Touch-panel.



ATTENTION! HOT MATERIALS AND/OR HIT SURFACES!  
DANGER OF BURNING! ALWAYS WEAR HEAT-PROTECTION-GLOVES!

-After reaching the desired (selected) temperature the IR1302 COMPACT keeps this constant by a pulsed switching of the infrared-tubes. As soon as the material is heated through (**might take some minutes with thicker materials**), it can be taken out of the oven. For this the door is opened as described above and the Pull out tray shall be pulled out of the oven as far as the material can be easily picked up. NOTE: As soon as the oven door is opened, the IR-tubes are deactivated automatically to save energy.

Should the oven not be in use at this time any more, turn it off in the meantime, resp. deactivate the infrared tubes by pushing the STOP button. As the infrared system doesn't require any pre-heating a lot of energy can be saved this way.

### 3.3. Heating of plastics with a Blister-Forming frame

To process Prosthetic socket materials in Blister forming trays the Pull-out tray needs to be disassembled. Please refer 2.2.2.1 to do so.

- The IR1302 COMPACT is turned on by use of the ON-OFF main switch (pic. 11 (A)). After the Start screen shows up the operation mode is selected by pushing the START button
- by pushing the green SET temperature it can be adjusted to material to be heated. The number will be set by pushing the ENTER button at the keypad.

ATTENTION! To get the best heating results the temperature recommended by the manufacturer should be selected! Selecting a higher temperature does **NOT** heat the material faster but overheats and burns the material and destroys the material most times!



ATTENTION! DANGER OF SELF-IGNITION  
OF OVERHEATED MATERIAL!

- The door of the oven is opened by turning the door handle and pulling it upright.
- Put the Blister-forming tray, resp. the cradle / stand at the bottom of the IR1302 COMPACT. For a perfect heating process take care of the correct height (Material has to be at the height of the upper edge at the backside of the housing) of the frame resp. the cradle / stand. Place the center of the frame at the bottom marking of the oven.

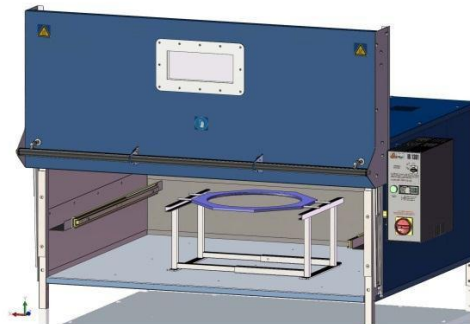

The material, clamped into the frame, should be placed right under the center pair of IR- tubes. **Be sure that the optical measuring unit still hits the outer part of the material and not the blister-forming frame (Diameter of the measuring spot is approx. 4" at this distance)!** Only thus a correct determination of the materials surface temperature is ensured! **Pay attention that the level of the material is never put higher than the upper edge at the backside of the oven! If the material is put closer to the IR-tubes an uneven heating will be the result! (See additional notes enclosed).**

-By use of the HEATING SELECTION feature the size of the heated area can be selected. When working with blister forming trays the use of the entire heating area has been proved. Even if most blister forming materials for prosthetic sockets have quite the same width like the central Infrared tubes of the oven, the heating process can take more time due to the higher thickness of the materials. This reduces the energy saving effect of the small zone and the time saving aspect is mostly more important.

CENTER ZONE = activates 6 central infrared tubes  
(for small pieces of material)

OUTER ZONE = activates 12 outer infrared tubes  
(for larger pieces of material + Blister forming)

-The heating process will be started by pushing the PERM START button - or if desired by pushing the TIMER START button.

-Now the heating process can be observed at the front-door's viewing window or the CURRENT temperature displayed at the Touch-panel.



**ATTENTION! HOT MATERIALS AND/OR HIT SURFACES!  
DANGER OF BURNING! ALWAYS WEAR HEAT-PROTECTION-GLOVES!**

-After reaching the desired (selected) temperature the IR1302 COMPACT keeps this constant by a pulsed switching of the infrared-tubes. As soon as the material is heated through (**might take some minutes with thicker materials**) and sagged sufficiently it can be taken out of the oven. NOTE: As soon as the oven door is opened, the IR-tubes are deactivated automatically to save energy.

Should the oven not be in use at this time any more, turn it off in the meantime, resp. deactivate the infrared tubes by pushing the STOP button. As the infrared system doesn't require any pre-heating a lot of energy can be saved this way.

### 3.4. Specials

The tray of the IR1302 COMPACT infrared oven is equipped with a nonstick Teflon coating. When necessary some talc (powder) can additionally be used to prevent the heated materials from sticking.

### 3.5. Pre-Preg Hose duct

The IR1302 COMPACT is equipped with a standard hose duct. This is used to lead a vacuum hose for Pre-Preg or other applications inside the Infrared-oven. The hose duct is located at the left side of the housing and can be covered with the included cap when not in use.

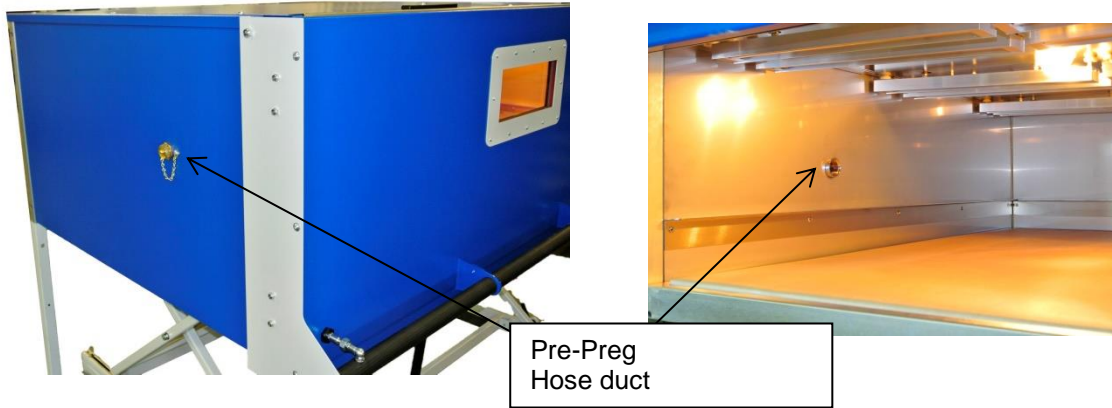

## 4. Care and maintenance

### 4.1. Oven housing

The housing of the IR1302 COMPACT oven is maintenance-free. It might be regularly cleaned from dust in- and outside with a soft cloth.

### 4.2. Front-door

The ball-bearing-guides on both sides of the front-door should be cleaned from dust with compressed air regularly. Once a year the ball-bearing-guides should be greased with oil or lubricant (The easiest way to do so, is to put some oil at the top of the ball bearing guides, so it can run down the bars and the ball bearings inside.) **ATTENTION! In case of a malfunction (loss of pressure etc.) the gas-shock has to be replaced completely. Never try to repair a gas-shock by yourself. Gas-shocks have a very high pressure inside. Opening or manipulation of gas-shocks can cause serious injuries!**

### 4.3. Quartz-Infrared-Tubes

The 18 quartz-infrared-tubes of the IR1302 COMPACT are mounted on top of the oven. To guarantee a long lasting lifetime they should be turned on only when the oven is in use (pre-heating of the oven is not necessary and provides no advantage to heat the materials) The (**cooled**) tubes can be cleaned from dust with a soft and dry cloth.

Quartz-infrared tubes have a wear out. Thus the heating capacity of the tubes can decrease after a few years of application. The tubes can be replaced one by one as described below. As there are also workings at the electricity, only authorized electricians are allowed to do this.

**-First unplug the power cord of the oven and be sure that the unit will stay unplugged while you are working on it. The oven has to be cooled completely for the workings.**

-Remove the 12 screws M6 on top of the ovens cover (pic. 15).



pic. 15

pic. 16



-Now lift the cover at the front side and support it with a suitable object (lath 30cm (12") long) (pic. 16).

- The quartz-infrared tubes will be replaced completely with their aluminum case (reflector). Each radiator (tube + case) is mounted to the top of the oven case with two sleeves M5 and has two connecting cables. (pic. 17).

pic. 17

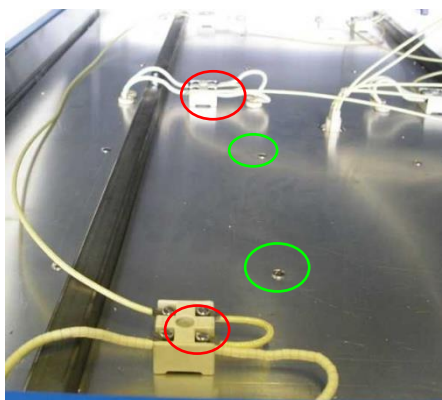

- Identify the radiator which you want to replace and loosen the two associated connection cables (red circle) at the respective connecting terminal.
- Now loosen the two screws M5 (green circle) of the respective radiator and pull it out of the case to the underside.
- Next you can mount the new radiator by sliding the sleeves into the drill holes of the oven from the underside again. Pay attention to slide the two connection cables into the ceramic guides also and don't damage the ceramic insulation of the connection cables. The springs on the sleeves should rest against the underside of the upper aluminum plate of the heating area.
- Now fix the new radiator with the two sleeve nuts M5 again and tighten them.
- Connect the two connection cables to the respective connecting terminal again. Pay attention that you connect possibly cables of other radiators to the same terminal!
- If you plan to replace more than one radiator follow the instructions above. However you should change the radiators one after another to avoid wiring mistakes.
- Finally you can close the oven cover and fix it with the screws. **IMPORTANT! Pay attention that you don't squeeze the connection cables of the cooling fan, mounted in the cover.**



#### 4.4. IR Optical measuring device

The optical measuring device is mounted between the radiators in the top of the oven (pic. 18). It is generally maintenance-free. However after a while dust and other soiling can cover the lens of the sensor and corrupt the measuring results. So a periodical cleaning (~every three month) helps to avoid malfunction. Clean the lens (cold oven) with a soft cotton pad or a soft cloth. Persistent residues can also be removed by use of some water at the cloth.

pic. 18



#### 4.5. Illumination

The illumination consists of two special heat resistant 25watt bulbs. If one of the bulbs is defective you first have to remove the glass cover (cold oven) of the bulb by hand. After this you can replace the bulb inside of the lamp by a new one. **ATTENTION!** Always use special heat resistant bulbs of the same type and the same capacity (25W). The use of other bulbs can lead to malfunction of the bulbs or the oven!

#### 4.6. Pull-out-tray

The ball-bearing guides of the Pull-out-tray should be cleaned by use of compressed one a year or if necessary. The easiest way to do so is to disassemble the tray first.

#### 4.7. Teflon coating

The material tray of the Roll about tray is equipped with a replaceable Teflon-coating. To guarantee a long lasting lifetime the Teflon coating should be cleaned regularly (once a week) with a soft and dry cloth from contamination of talc or plastic residues.

If the teflon coating is damaged or contaminations cannot be removed any more the coating can be replaced by a new one. The following instructions should be followed to do so:

- The tray need to be lifted with two persons out of the upper frame of the Roll about tray (material tray is only laid on it and not fixed any more).
- The material tray need to be placed upside down on a large table or the like.
- At the underside the teflon has three belts alongside and two belts crosswise which are all fixed by springs (pic. 19). First the springs are taken off. **ATTENTION! Take care to hold on the springs. Flying springs may cause injury.**
- Now the material tray (consisting of aluminum trough, insulation and heat resistant layer) without the old Teflon coating is lifted by two persons and set aside.
- Next the old Teflon coating is replaced by the new one and the material tray is placed concentric on it. The three short belts of the alongside are the front end of the tray.

- Wrap around the belts of the teflon coating and fix them with the springs.
- ATTENTION! Take care to hold on the springs. Flying springs may cause injury.**
- Finally the newly covered material tray is placed into the frame of the Roll about tray.  
The measuring area marking under the teflon coating needs to be aligned to the front side of the Roll about tray. .

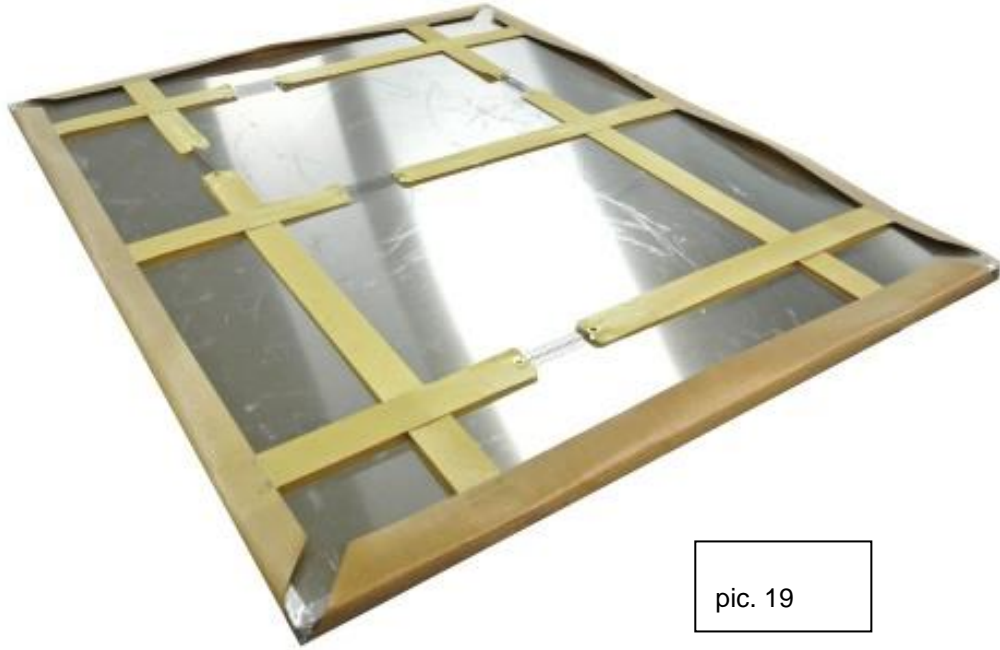

pic. 19

## 4.8. Breaker / Fuse

### 4.8.1 Master breaker

The IR1302 COMPACT is equipped with an automatic triple circuit breaker which trips in case of a short circuit or fault and shuts down the entire oven. Should the breaker be tripped it can be reset as follows.

The breaker is located inside of the black switchbox. **ATTENTION! First turn off the oven by use of the main switch and unplug the oven and ensure that the unit will stay unplugged while you are working on it.**

Open the switchbox by removing the 4 screws (2 on top + 2 on bottom) of the outer switchbox cover. After removing the cover, the breaker can be checked and reset if necessary. If the breaker should trip again, please contact our technical support.



Abb. 20  
NOTE: Pic. Shows 3 phase version

#### 4.8.2 Micro fuse

Beside the master breaker the oven is equipped with a 2A (time delay) fuse to protect the 24 VDC transformer. This fuse is located in a black fuse-holder to the right of the transformer. A defective fuse is visualized by a lighted orange LED on top of the fuse-holder.

**ATTENTION! First turn off the oven by use of the main switch and unplug the oven and ensure that the unit will stay unplugged while you are working on it.**

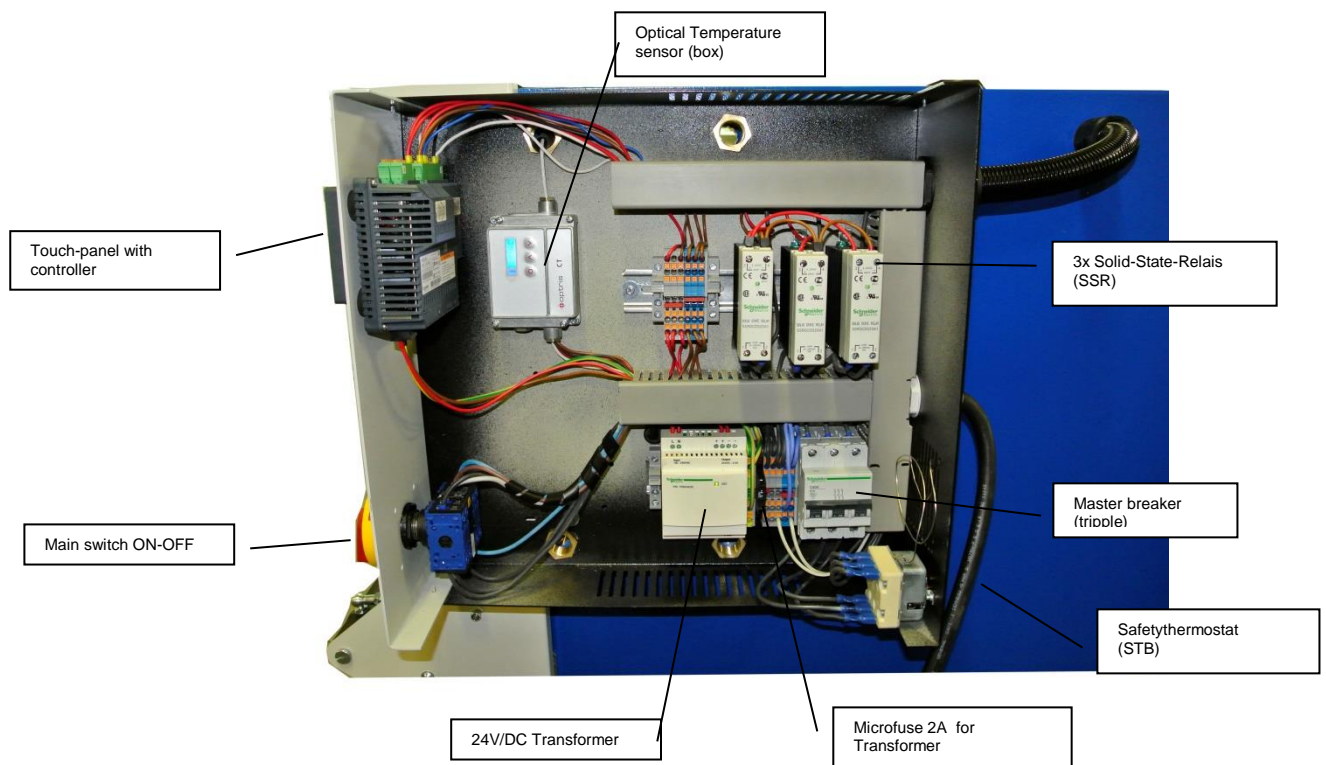
To replace the fuse the upper part of the fuse-holder needs to come off to the top. This part can be opened and the fuse can be replaced. The fuse may just be replaced by an identical one (230V / 2A / time delay).

#### 4.8.3 Safety-Thermostat

In case of a malfunction of the Temperature control system, the IR1302 COMPACT is equipped with a safety-thermostat (STB) which shuts down the oven when overheated. In that case the oven is shut down completely. The STB is located at the backside of the black switch-box. After the STB has tripped, turn off the main-switch (A) and let the oven cool down. After the oven has cooled down, you can reset the STB by pushing the red button until you hear it locking. Should the STB trip again, please contact our technical service.

### 4.9 Error messages and Rectification of defects

#### 4.9.1. Error message

For error messages and warnings of the microprocessor control unit, see section 2.3.1.5..

#### 4.9.2. Rectification of defects

The IR1302 Infrared oven is equipped with various fuses to protect the user, surroundings and certain of its components. Triggering the fuses can lead to the symptoms described below.



**DANGER**

Work on electrical equipment and components may only be completed by trained, qualified personnel or licensed electricians!

#### **A) The oven is entirely non-functional after switching it on:**

- 1) There is a problem with the power supply to the oven. For proper operation, all three phases as well as N and PE of the CEE outlet have to function correctly. Check the fuses on the building side if applicable. Contact customer service if the problem recurs.
- 2) The safety temperature limiter was triggered.  
In case of thermostat control malfunctions, the oven may overheat and trigger the safety temperature limiter. The cause of the thermostat control malfunction must be determined and eliminated. The oven has to be cooled to room temperature. Then the

safety temperature limiter on the back of the control unit box can be reset. Contact customer service if the problem recurs.

- 3) The main circuit breaker of the oven was tripped.

In case of a problem with the electrical system, the main circuit breaker (3x 16A circuit breaker) in the control unit box may be tripped. To reset the main circuit breaker, the exterior cover of the control unit box has to be removed. First switch off the oven and pull the mains plug. Then remove the upper and lower exterior screws on the control unit box cover. Once the circuit breaker has been reset, close the control unit box and reconnect the mains plug. Contact customer service if the problem recurs.

**B) After powering up, the interior lighting of the oven works, but the control unit is entirely non-functional:**

- 1) The micro-fuse of the 24VDC transformer has blown. To replace the micro-fuse, the exterior cover of the control unit box has to be removed. First switch off the oven and pull the mains plug. Then remove the upper and lower exterior screws on the control unit box cover. The micro-fuse is installed in a black plastic fuse holder next to the transformer. The upper half of the fuse holder is flipped up and then the side cover is opened. Replace it only with a micro-fuse of the same type (20x5mm, 230V / 2A). Once the fuse has been replaced, close the control unit box and reconnect the mains plug. Contact customer service if the problem recurs.

**C) The thermostat control of the oven is not operating correctly. The material is overheated even if the correct temperature is preset:**

- 1) The thermostat control of the oven is operating with an optical sensor. The sensor is equipped with a special glass lense. If this lense is dirty the optical sensor cannot measure the correct temperature of the material. For detailed instructions how to clean the lense and fix the problem refer to section 4.4.. Contact customer service if the problem recurs.

# 5. Circuit diagram

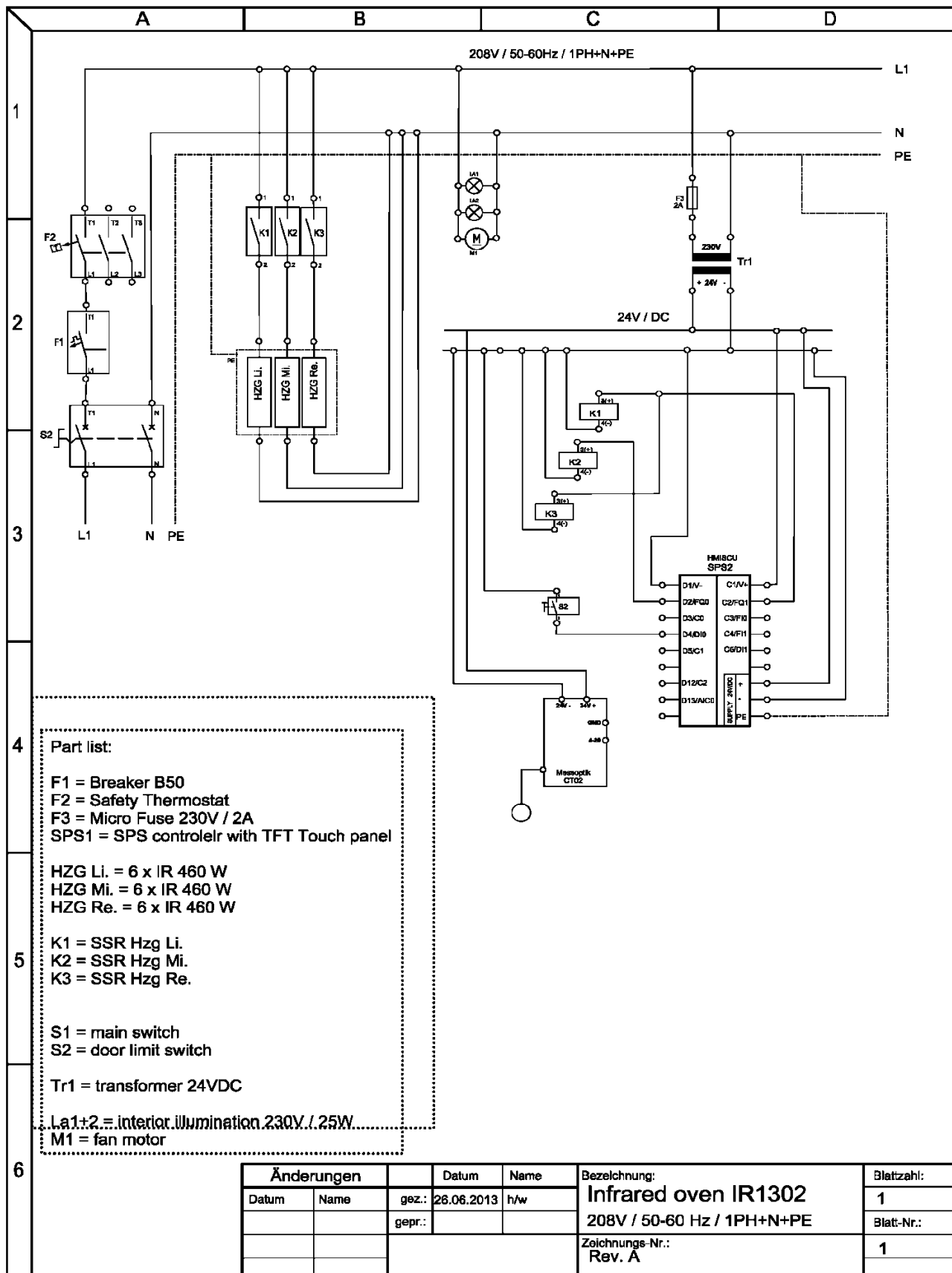

## 6. Spare parts

<b>Part No.</b>	<b>Description</b>
07-130-001	gas-shock door 200N (2 pc.)
07-130-004	Double pane viewing window (incl. Silicon sealing)
07-130-005/002	Silicon door sealing (set, left + right)
07-130-005/003	Door sealing (lateral), Aramid felt with silicone
07-130-006	Optical infrared temp. sensor with electronic box
07-130-008C/460-485	Infrared-tube 460W / 490 mm completely with reflector (6 pc.)
07-130-008C/460-385	Infrared-tube 460W / 390 mm completely with reflector (12 pc.)
07-130-009/P	Teflon-coating porous for Pull out tray, completely with attachment belts
07-130-011	Cooling fan for IR-Temperature sensor
07-130-012/1	Automatic circuit breaker
07-130-012/2	Micro fuse for transformer (2A / time delay)
07-130-013ST	SCHNEIDER Solid State Relay 20A1
07-130-014	Door guides (kit = 2 pc.)
07-130-014/A	Door guides stop (kit = 2 pc.)
07-130-014/G	Door guides rubber damper
07-130-015	Illumination bulb for interior light (25W)
07-130-018	SCHNEIDER Transformer 2,5A / 24V DC
07-130-020	Safety Thermostat (STB)
07-130-021	Main switch KF20
07-130-026/2	Door contact limit switch
07-130-040	SPS Controller with Touch-panel 3,5"
07-130-040/F	Protection film for Touch-panel 3,5" (set of 5pc.)

## 7. Technical Details

Type:	Infrared-Oven IR1302 COMPACT for the O&P field
Manufacturer:	Witzel VACUPRESS e.K. Max Keith Str. 66 – D-45136 Essen – Germany Tel. +49-201-6462-284 Fax +49-201-6462852
Height:	740 mm (29")
Width:	1595 mm (62")
Depth:	1270 mm (25.5")
Roll about ray:	1245 mm (50") x 1045 mm (41") (usable area W x T) Continuously height adjustable 820 mm (31") – 1050 mm (41,2")
Footprint:	1,9 sqm
Weight:	230 kg
Voltage:	208 V / 50-60 Hz / 1 Phase (1x 50A)
Capacity:	8,5 kW
Heating:	18 Infrared-Quartz tubes with single reflector
Temperature-control:	opto-electrical by IR sensor Continuously 30-250°C (90-465°F), Electronic SPS Controller with 3,5" Touch panel Interface
Illumination:	2 x 25W bulbs



## 8. Declaration of Conformity

### Declaration of Conformity

for the Infrared-oven IR1302 COMPACT  
(Art.Nr. 07-132C-400-3, 07-132C-220-3, 07-132C-220-1)

**Witzel VACUPRESS e.K.**  
**Max Keith Str. 66 / D-45136 Essen**

declares as manufacturer and in sole responsibility that the Infrared-oven IR1302 COMPACT complies with the fundamental requirements of the directive 2006/42/EG and the directives listed below - including all changes, valid at the time of declaration.

The following additional EU-directives have been applied:

2006/95/EG  
2004/108/EG

The following harmonized standards have been applied:

DIN EN ISO 12100-1, DIN EN ISO 14121-1  
DIN EN 60204-1, DIN EN 60335-1, DIN EN 60335-2-48  
DIN EN 55014-1, DIN EN 55014-2

Name and address of the person who is authorized to assort the technical documents: Hendrik Witzel

Witzel VACUPRESS e.K.  
Hendrik Witzel



Essen, 19.12.2013







